



www.sihga.com

Pfulu®

SICHERHEIT IM HOLZBAU GARANTIERT AUSSERGEWÖHNLICHES

MA Nr. 38332/19/2

SIHGA APP

GET IT ON Google Play

Download on the App Store

TAKE THE BEST



SIHGA® GmbH | 4694 Ohtsdorf bei Gmunden | AUSTRIA  
 Tel.: +43 7612 - 74 370 - 0 | Fax DW 10 | E-Mail: info@sihga.com | www.sihga.com



Pfulu®



GoFix® S+ 8,0 x 195



BeziFix® Anker ZF 7,5 x 60



Stabebo® SDS Bohrer 6,0 x 160

1. a

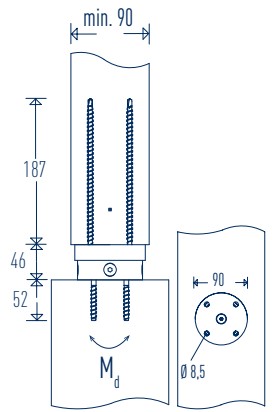

Dimension	GoFix® S+	BeziFix® Anker ZF	max. Moment
Pfulu®	d <sub>i</sub> x L	d <sub>i</sub> x L	M <sub>d</sub>
Ø x h	[mm]	[mm]	[kNm]
90 x 46	8,0 x 195	7,5 x 60	1,50

1. b

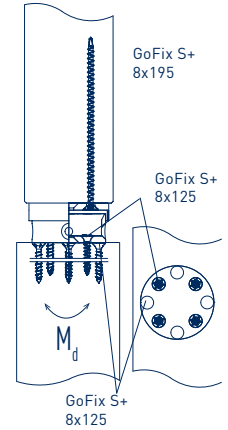

Dimension	GoFix® S+	GoFix® S+	max. Moment
Pfulu®	d <sub>i</sub> x L	d <sub>i</sub> x L	M <sub>d</sub>
Ø x h	[mm]	[mm]	[kNm]
90 x 46	8,0 x 195	8,0 x 125	1,25

3.

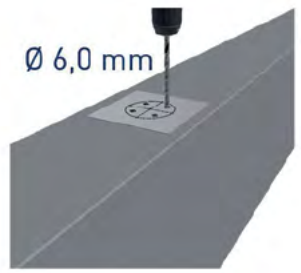
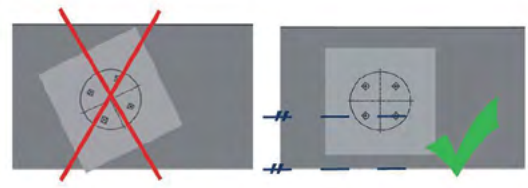

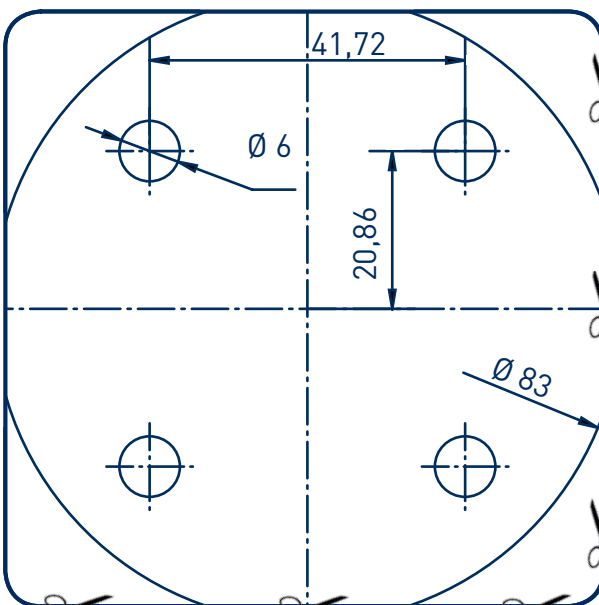

3.

4 x BeziFix® Anker ZF 7,5 x 60

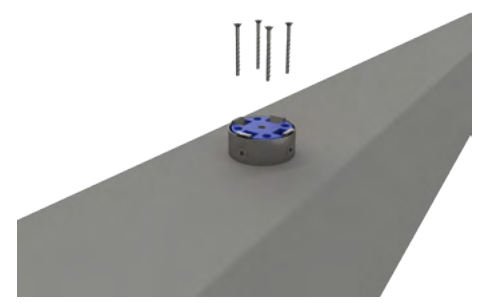

4.

4 x GoFix® S+ 8,0 x 195

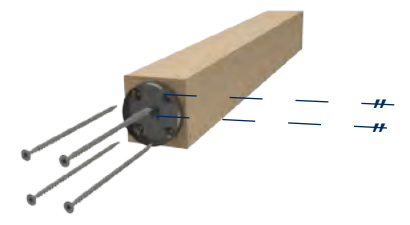

5.

- 1
- 2 1 x ~360°

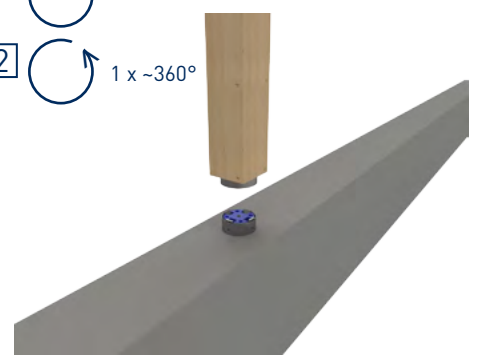

6.

$\pm 4^\circ$

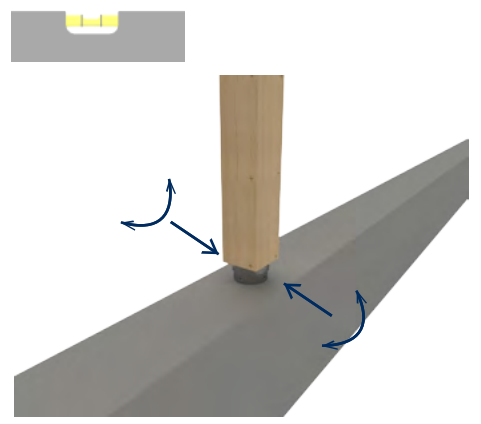

7.

$\pm 4^\circ$

