

JustiFix® II JK

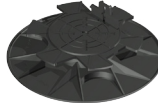

JustiFix® JK 50 H



JustiFix® II JK 50 S

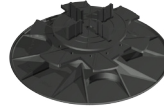

JustiFix® II JK 50 SF

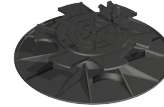

JustiFix® II JK
90 H/125 H / 160 H

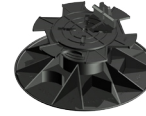

JustiFix® II JK
90 S/125 S/160 S

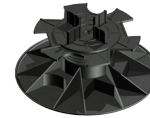

JustiFix® II JK
90 SF/125 SF/160 SF

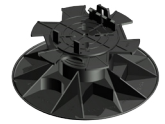

JustiFix® JA 70



TAKE THE BEST®



SIHGA

JustiFix® II JK

MA. Nr. 38483/18/1

A 1 JustiFix® JK 50 H / II JK 50S / II JK 50 SF



=



30 - 50 mm



30 mm

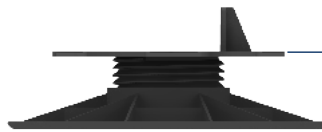

50 mm

B 1 JustiFix® II JK H / JK S / JK SF

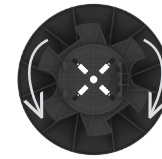

=



Justierbereich

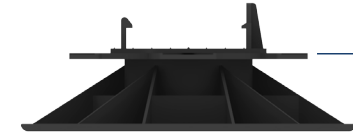

von

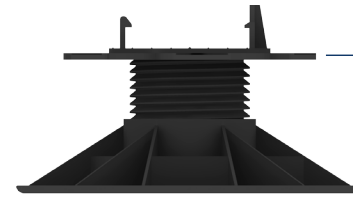

bis

TAKE THE BEST



Dimension	Justierbereich		Auflagefläche
JustiFix® II JK	von	bis	Durchmesser
Type	[mm]		[mm]
50	30	50	210
90	50	90	210
125	50	125	210
160	120	160	210

A/B 2

JustiFix® II JK

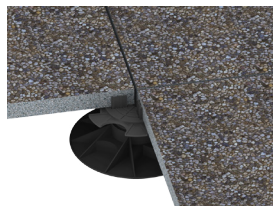

JustiFix® II JK H



JustiFix® II JK SF



C 1

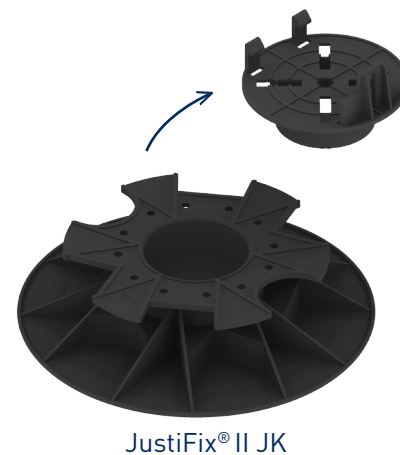

C 2

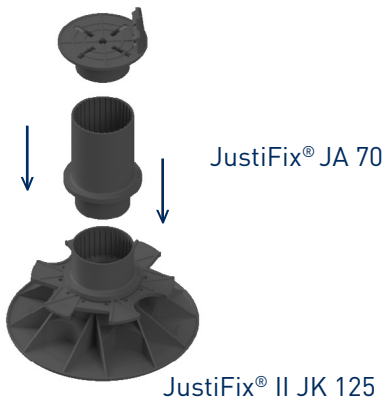

C 3

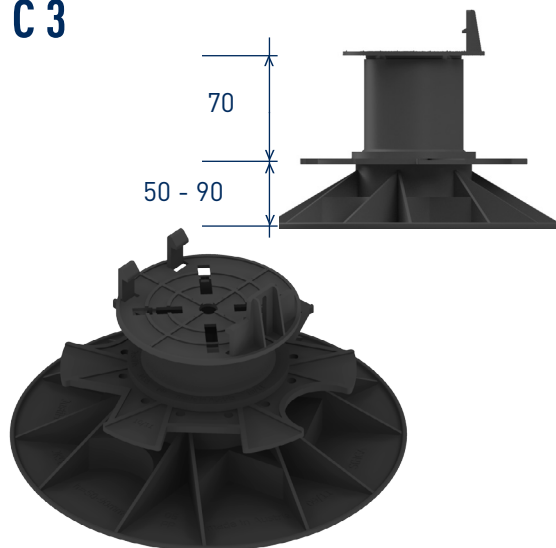

C 4

