

Dimensioning template

for insulation on rafters

For compression-resistant insulating materials

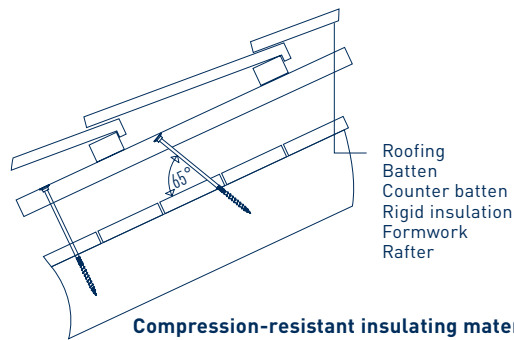

Compression-resistant insulating materials
(compressive stress at 10 % compression over 50 kPa)

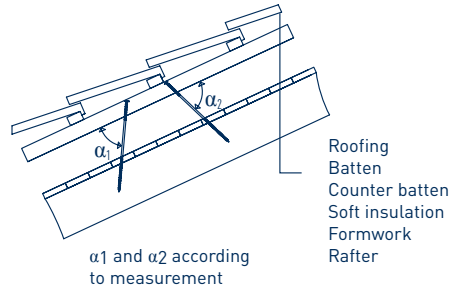

Soft insulating materials
(compressive stress at 10 % compression under 50 kPa)

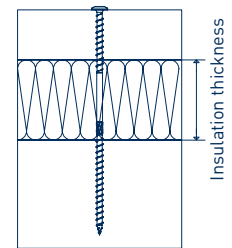

Executing company			
Contact person			
Postcode		Place	
Phone		Fax	
E-mail			
Building project			

Exact address of the building project for load determination:

Street		Number	
Postcode		Place	

Building:

Gabled roof

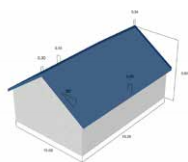

Hipped roof

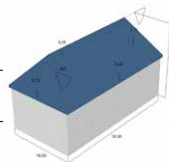

Pitched roof

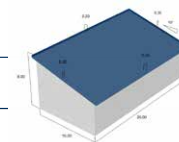

Length of eaves [m]:	Wide gable end [m]:	Slope of the roof [°]:
----------------------	---------------------	------------------------

Roof:

Eaves overhang [m]:	Overhang on verge [m]:	Ridge height [m]:
Hip inclination [°]: (Hipped roof)	Overhang ridge [m]: (Pitched roof)	
Screw connection ONLY insulation surface	<input type="checkbox"/> Yes <input type="checkbox"/> No	

Insulation:

Typ	<input type="checkbox"/> simple	<input type="checkbox"/> assembled	<input type="checkbox"/> pressure-resistant	<input type="checkbox"/> pressure soft
-----	---------------------------------	------------------------------------	---	--

Insulation (single or lower insulation type, if assembled):

Insulation, name:		Compressive stress:	
Thickness/height [mm]:		Modulus of elasticity:	
of which thickness of wood-based material [mm]:		Thermal conductivity [W/mK]:	

Insulation (upper insulation, only fill in if assembled):

Insulation, name:		Compressive stress:	
Thickness/height [mm]:		Modulus of elasticity:	
of which thickness of wood-based material [mm]:		Thermal conductivity [W/mK]:	

Rafter/Formwork/Batten:

Rafter:

Material:	<input type="checkbox"/> Softwood	<input type="checkbox"/> Glulam	<input type="checkbox"/> Cross laminated timber
Strength grade:			
Width x height [mm]:	Centre distance between rafters/battens [mm]:		

Formwork:

<input type="checkbox"/> Yes <input type="checkbox"/> No	if „Yes“ Thickness [mm]:
--	--------------------------

Batten:

Counter battens:	<input type="checkbox"/> Battens	<input type="checkbox"/> Plates
Strength grade:		
Width x height [mm]:	Length [mm]:	
Roof battens:	<input type="checkbox"/> Yes <input type="checkbox"/> No	if „Yes“ Distance [mm]:

Tip: Our dimensioning software is available to download free of charge at www.sihga.com!

Load:

Roof covering and roof battens [kN/m ²]:	Snow guard <input type="checkbox"/> Yes <input type="checkbox"/> No
--	---

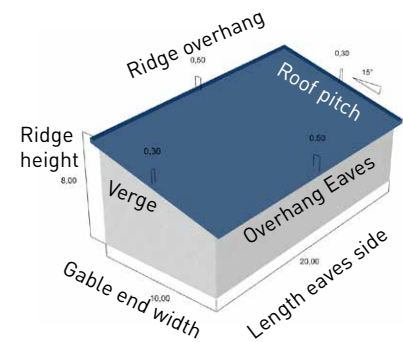
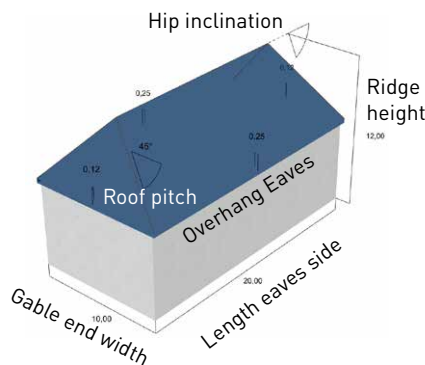
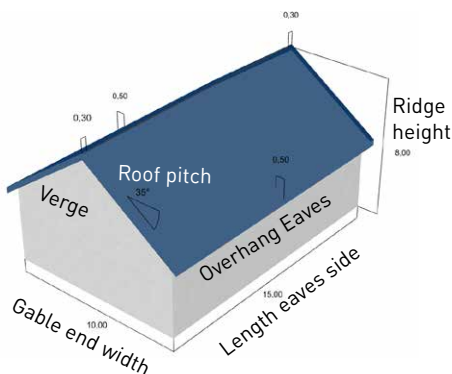

Accurate completion of the dimensioning template enables fast and reliable dimensioning.